

VIAVI

CellAdvisor™

JD720C Series Cable and Antenna Analyzers

The majority of problems in mobile networks occur in cell-site infrastructure, consisting of the antenna system, RF and fiber cables, and connectors. Properly servicing and installing cell sites requires suitable test equipment. VIAVI Solutions® CellAdvisor JD720C analyzers are the optimal test solutions for characterizing cell-site infrastructure due to their handheld design, ease of use, and rich functionality.

JD720C analyzers have all of necessary measurement functions to characterize cell-site cable and antenna system, including VSWR or return loss reflection tests, distance to fault (DTF), and cable loss. It also can perform RF component measurements, including insertion gain/loss, antenna isolation, TMA performance, and verification of devices such as duplexers and combiners.

The instrument's 7-inch color touch-screen display simplifies its operation and clearly displays measurement results. Its connectivity to VIAVI Solutions application software allows for easier measurement analysis and report generation.

In addition, JD720 analyzers are capable of fiber inspection using the VIAVI fiber microscope and optical power measurement using VIAVI optical power meters. This single integrated solution with RF and fiber capabilities provides all the physical layer tests needed for the installation and maintenance of cell sites.

Key measurements include:

- Reflection — VSWR/Return Loss
- DTF — VSWR/Return Loss
- 1-Port Cable Loss
- 1-Port Phase
- Smith Chart
- 2-Port Transmission*
- 2-Port Phase*
- RF and Optical Power Meter
- Fiber Inspection
- High-Power CW Signal Generator*



Benefits

- RF and fiber testing in single-box solution
- Manage assets and reduce costs with cloud-enabled StrataSync™ Core at no charge
- Detect signal degradation over time with Trace Overlay
- Reduce test time in simultaneous and dual measurement mode
- View pass/fail results instantly
- Calibrate faster and easier with EZ-Cal™

Features

- Perform self-guided systematic test procedures with TestWizard
- Inspect fiber with pass/fail indications using P5000i fiber microscope
- Measure RF and optical power using power sensors
- Three zoom zones for detailed analysis on multi-frequency bands
- Up to 40 dBm (10 W) RF port protection
- Generate PDF/HTML reports
- Automatically saves events that exceed pre-defined limits
- Application software for post-analysis (JDViewer) and remote control (JDRemote)
- Web-based remote control via Bluetooth and Wi-Fi

Applications

- Verify cell-site cable and antenna systems
- Test distributed radios with RF and fiber feed lines
- Validate DAS deployments
- Test NFC antennas (RFID and security equipment)

JD725C Top View

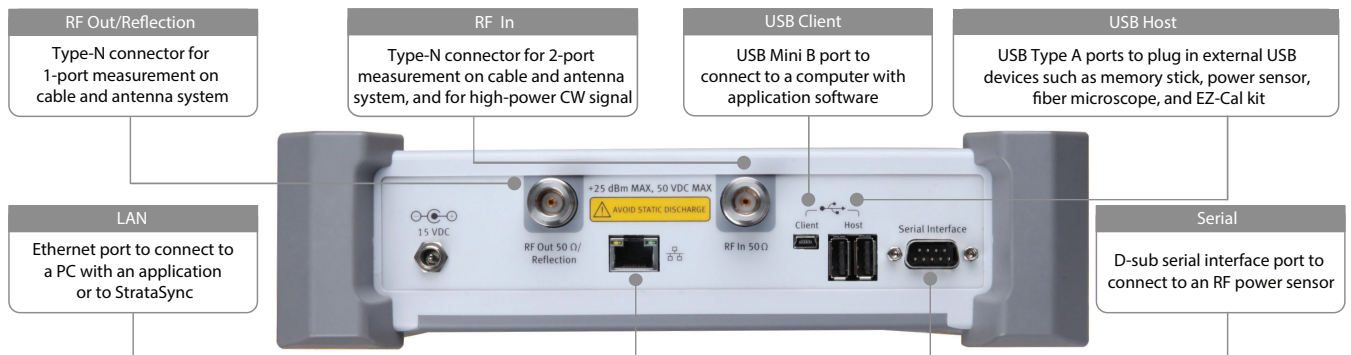

JD725C Front View



Key Measurements

Reflection measures the cell-site transmission line impedance performance across the selected frequency range in VSWR or Return Loss.

- The instrument's database includes over 80 wireless frequency bands with the ability to add more.
- A user-definable limit line automatically indicates pass/fail status.
- Users can set up to six markers for trace analysis.

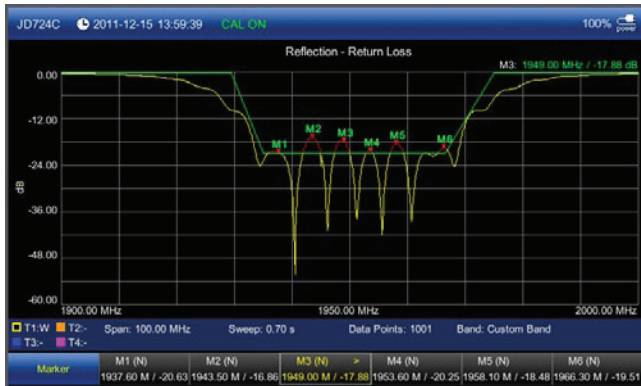

Reflection — Return Loss

Distance to Fault (DTF) identifies fault locations in the cell-site transmission system indicating signal discontinuities using VSWR or Return Loss.

- Cable length up to 1,500 m (4,921 ft)
- High-resolution mode with 2001 data points.
- The instrument's database includes over 95 cable types with the ability to add more.
- A user-definable limit line automatically indicates pass/fail status.
- Users can set up to six markers for trace analysis.



DTF — VSWR

1-Port Cable Loss measures the signal loss through cables or other devices over a defined frequency range.

- A user-definable limit line automatically indicates pass/fail status.
- Users can set up to six markers for trace analysis.

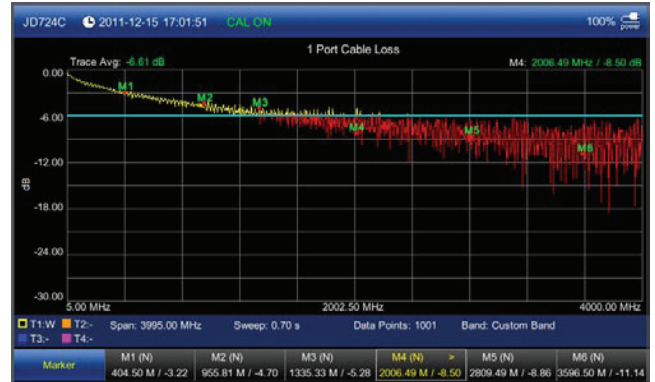

1-Port Cable Loss

1-Port Phase measures S_{11} phase to tune antennas and to phase-match cables.

- Users can set up to six markers for trace analysis.



1-Port Phase

Smith Chart displays impedance matching characteristics in cable and antenna systems as well RF devices.

- Users can set up to six markers for trace analysis.

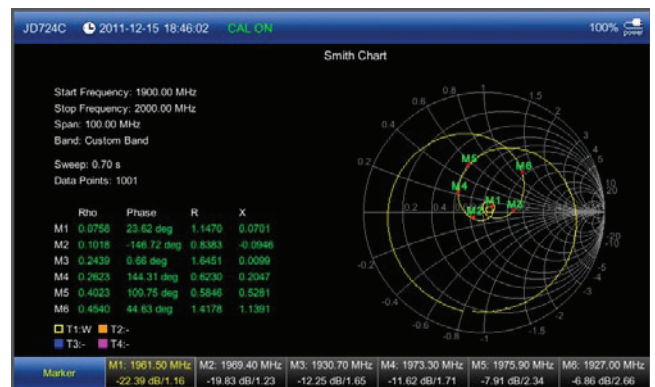

Smith Chart

2-Port Transmission* measures the characteristics of passive and active devices such as filters, jumpers, splitters, and amplifiers and verifies antenna or sector-to-sector isolation.

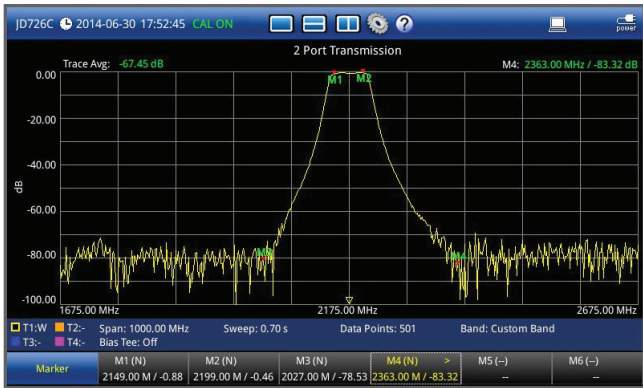

2-Port Transmission

2-Port Phase* measures S_{21} phase to characterize transmission devices such as filters and amplifiers.



2-Port Phase

Bias Tee (Option 001)*

The optional built-in Bias Tee supplies user-selected voltages of 12 to 32 V in 1 V steps on the RF-In port, eliminating the need for an external power supply.

Power Meter functions easily and comprehensively measure power using external power sensors and meters.

- JD72450551/2: economic RF power sensors via serial connection
- JD730 series: high-precision RF power sensors via USB connection
- MP-60/MP-80: optical power meters via USB connection



Power Sensors

The power meter displays either the RF/optical power level in two formats: as a real-time power level value in an analog meter and as a power level trend through time in a histogram chart. Its configurable settings include display range, maximum and minimum limits, and power units in dBm or watts.

Users can set minimum and maximum power limits for pass/fail status.



RF Power Meter

Fiber Inspection eliminates the most common fiber link problems by verifying that connectors are not contaminated. Interfacing with a VIAVI fiber microscope, fiber connectors can be quickly inspected with a clear pass/fail indication. Reports with pass/fail summary results can be automatically generated.

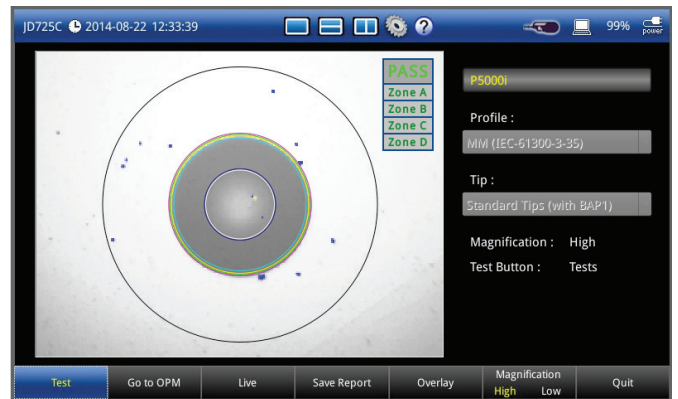

Fiber Inspection

High-Power CW Signal Generator (Option 005)*

The optional CW signal generator provides a continuous wave (CW) source for small cell coverage or DAS path loss testing.

Key Benefits

Designed for Field Use

Compact, lightweight JD720C analyzers are especially convenient for performing measurements in the field. The analyzers weigh less than 2.35 kg (fully loaded) and include a lithium ion (LiION) battery that lasts more than 75 hours.

Its transfective display can be set to an outdoor mode for viewing measurements in direct sunlight. Also, its backlit key panel with Night-Display mode makes it easy to use in the dark.

JD720C analyzers operate in -10 to +55°C temperatures; and its rugged bumper design protects it for field use, such as drop and vibration, complying with MIL-PRF-28800F class 2 specification.



Outdoor Display mode provides easier reading in direct sunlight

Quickly Sweeps

It can perform measurements in less than 0.8 ms/point, making these the fastest cable and antenna analyzers on the market with uncompromising fast sweep speed in Dual Display mode.

Multilanguage User Interface

The instrument supports multiple languages. Users can select their language of choice from English, French, German, Spanish, Portuguese, Russian, Chinese, Japanese, and Korean.

Easy to Use

Users can create favorite keys to conveniently access repeatedly used measurements rather than configuring them each time, reducing steps and completing tasks quicker and more efficiently. They can add editable key words to quickly create unique file names and can generate a PDF report directly from the instrument.

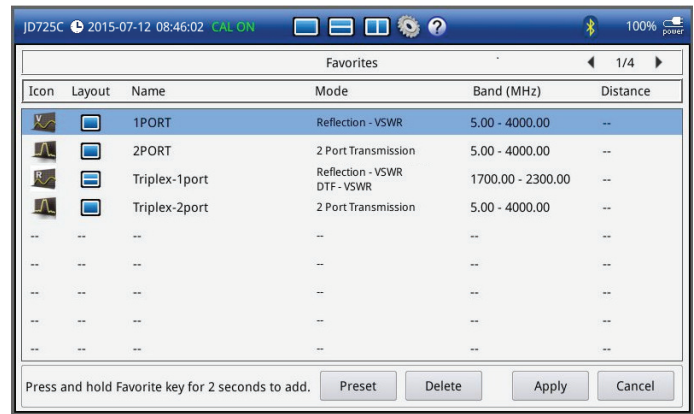

Favorite keys

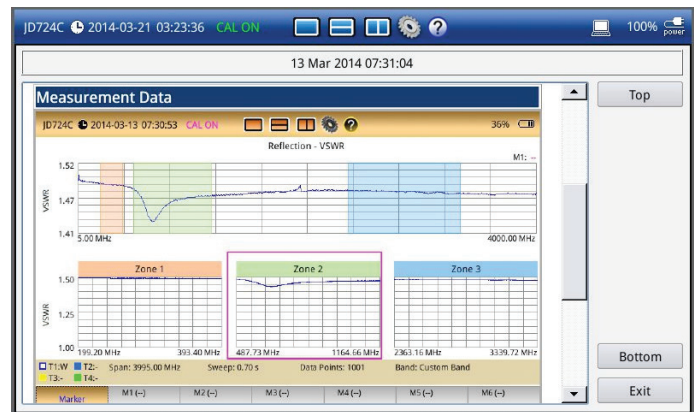

Report generation

The Quick Save hard key lets users simultaneously save a trace file and a screen file. If two measurements are displayed on the screen at once, it generates two trace files, one for each screen.

GPS Connectivity (Option 004)

This option provides getting position stamp and save the current measurement screen or data in a PDF report with GPS tag.

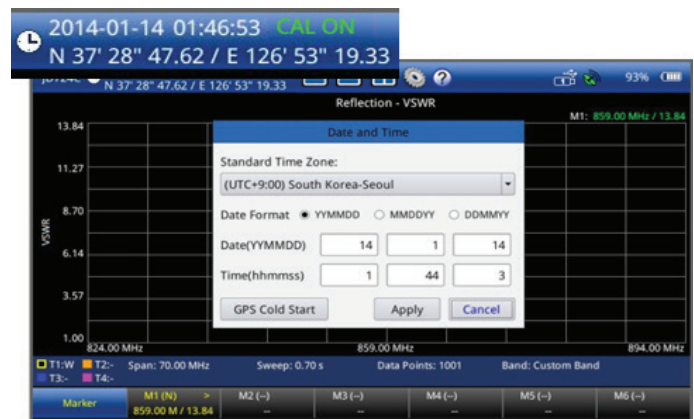

GPS position

Bluetooth Connectivity (Option 003)

This option provides wireless remote control and monitoring capabilities from a Windows®-based computer running JDRemote application software. This capability also lets users wirelessly connect to the cloud-enabled StrataSync by tethering the instrument with a smartphone or tablet.

WiFi Connectivity (Option 006)

This option provides a USB WiFi dongle for faster and more stable wireless remote control and monitoring capabilities from any web browser. Connectivity can be established from multiple computers or mobile devices.

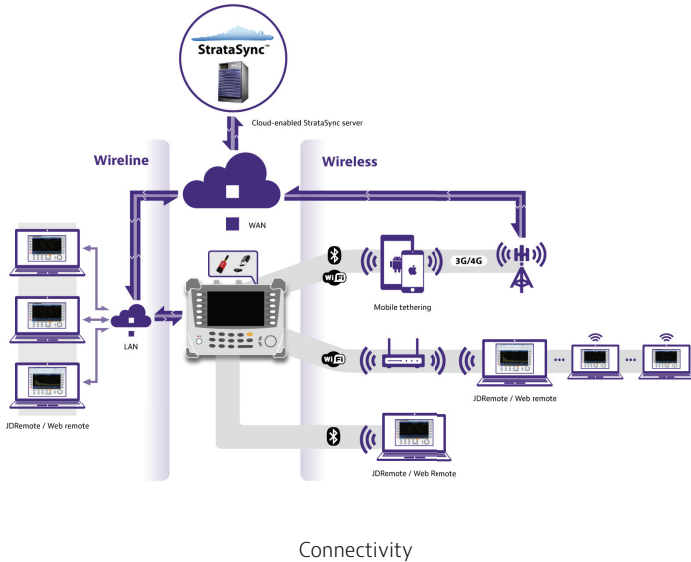

Connectivity

Test Wizard (Option 007)

This option enables any cell-technician to perform a systematically self-guide testing and make repeated measurements. They can simply run a pre-defined Test Wizard file that has been created in Test Wizard Creator application on a computer. Benefits of this option are:

- Reduce test time and workload
- Minimize manual work
- Collect consistent test results
- Require least training
- Work with StrataSync

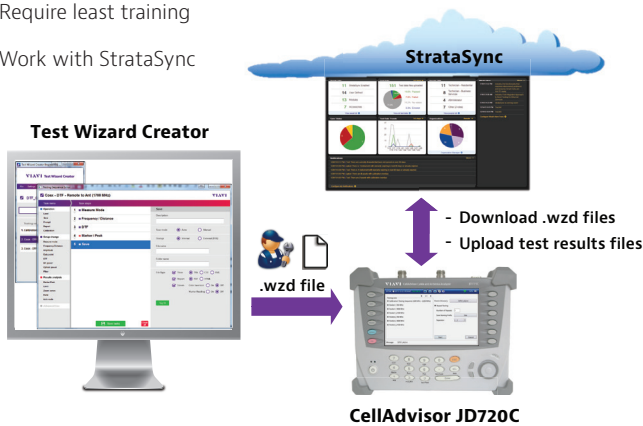

JDViewer Application Software

The JDViewer application software provides all of the necessary tools to operate these instruments more conveniently including:

- Quickly exchanges data via USB or LAN connection
- Retrieves or saves measurement results
- Exports measurement results
- Analyzes measurement results, assigning multiple markers and limit lines
- Registers or edits user-definable frequency bands and cable types
- Easily compares measurement results
- Converts VSWR/DTF traces
- Accesses available report templates
- Generates and prints reports

Expand Capabilities with Essential Fiber Handling Tools

- Optical power meter (MP series)
- Fiber inspection with pass/fail indication (P5000i fiber microscope)
 - MP-60/MP-80
 - P5000i fiber microscope



StrataSync Cloud Services Core and Plus

JD720C analyzers are compatible with the VIAVI StrataSync service to provide cloud-enabled asset, configuration, and test-data management.



Empower Your Assets:

- INSTRUMENTS: Manage and track test instruments
 - Display assets, modules, versions, and locations
 - Maintain accurate instrument configurations and setups
 - Provide visibility into instrument utilization
- WORKFORCE: Inform and train the workforce with:
 - Notifications and alerts
 - Procedures and instructions
 - Product-knowledge library
- RESULTS: Collect and analyze results with:
 - Centralized collection and storage
 - Secure visibility from anywhere
 - Consolidated test data/metrics

Key Features

Trace Overlay

Allows users to compare and analyze up to four traces by superimposing them into one measurement display.

Additionally, up to six markers can be set on any trace independently.

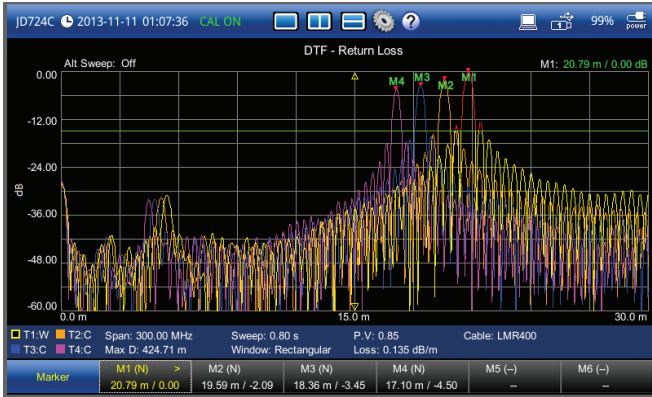

Trace overlay

Zoom Zones

User-definable frequency zones can be set to visually identify sub-band regions such as uplink and downlink frequencies to verify compliance within a single measurement and independent view for closer analysis of each zone.

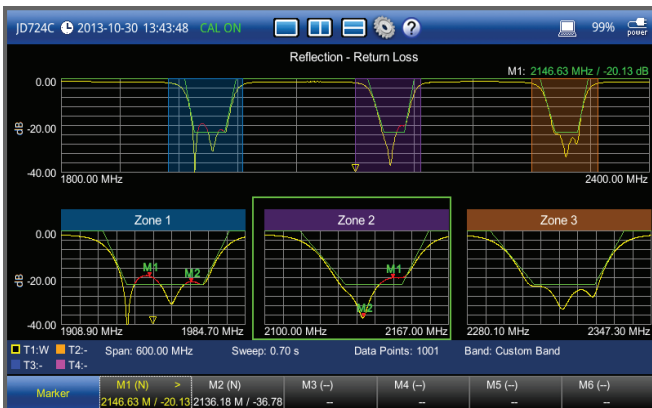

Zoom zones

Alt DTF Band

Allows users to perform two independent sweeps and to display the measurements, such as a reflection and a DTF, in the same window.

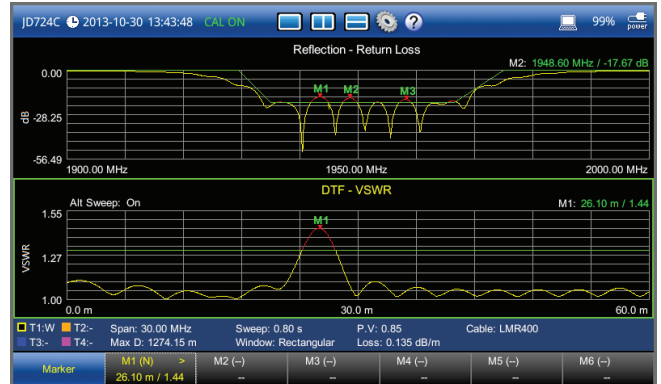

Alt DTF band

Dual Display

Provides the ability to display two measurements simultaneously, reducing test time.

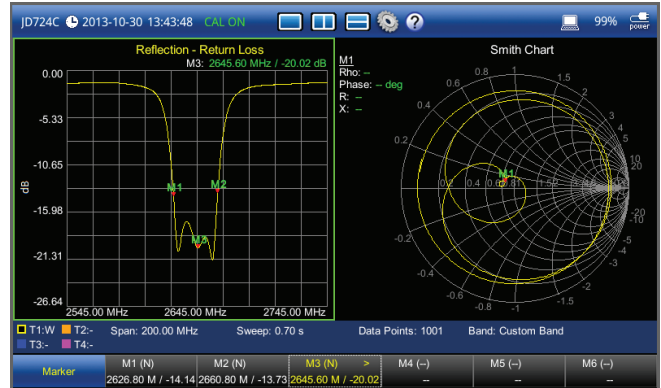

Dual display

Peak and Valley All Zones

Allows users to easily and automatically set markers to identify the trace peaks and valleys in each zone.

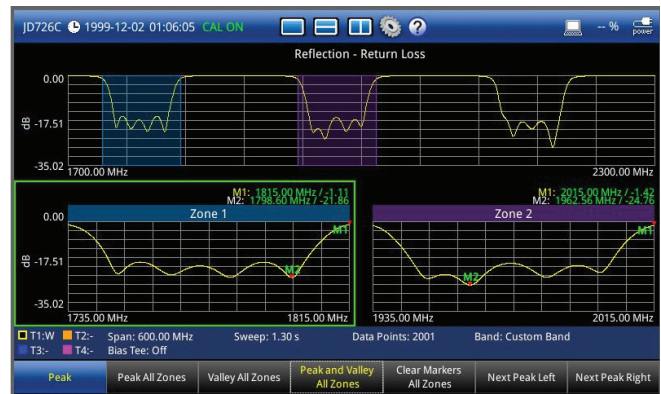

Peak and valley all zones

Limit Lines

Limit lines let users set variable testing thresholds with automatic pass/fail indication.

Standard Limit Line

The standard limit line extends over the full measurement frequency range and can be configured to indicate a fail when measurements exceed it. Users can also set a limit line for only specific sections.

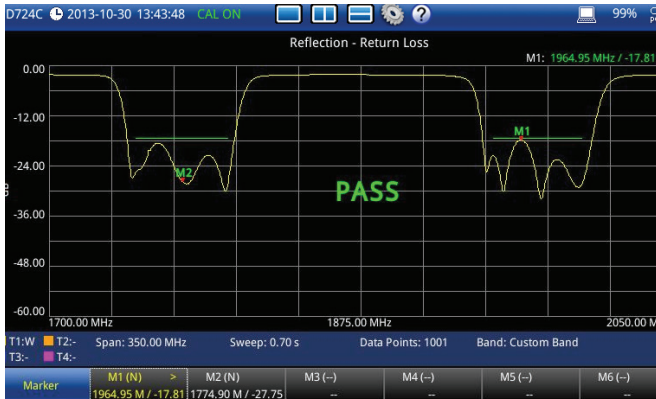

Straight line with gap

Multi-Segment Limit Line (MSL)

Multi-segment limits let users set upper- and lower-level thresholds for greater flexibility than single limit lines. Measurements falling within the muti-segment limit line boundaries are indicated as pass, while measurements outside the boundaries are indicated as fail.

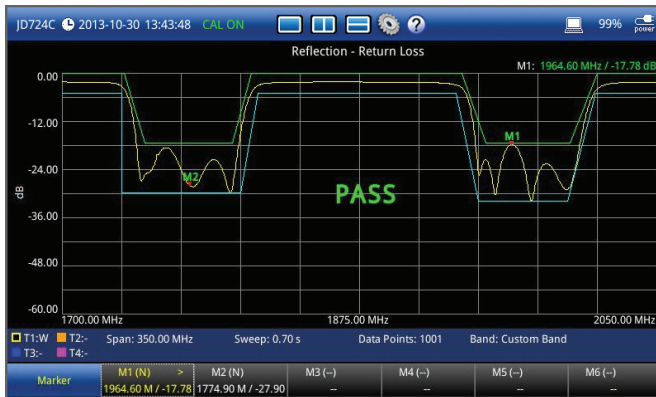

Multi-segment limit line with upper and lower thresholds

Window Limit

Window limit lets users define a measurement area in which to apply the test criteria. Measurements within the configured area are compared to the defined threshold and are indicated as pass/fail based on whether they fall within or outside the threshold. This capability is useful for tuning devices or antennas in real time.

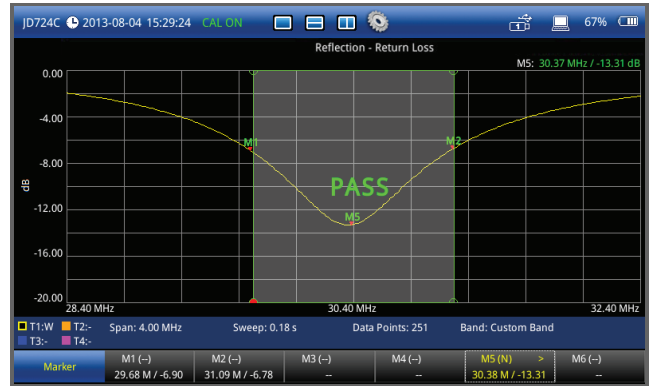

Window limit

Help Function

The Help function gives users task-based information related to instrument operation or the test performed. Users can then easily browse or search topics to get specific information.



Help function

Available Measurements and Options

	JD723C	JD724C	JD725C	JD726C
Reflection – VSWR and Return Loss	■	■	■	■
DTF – VSWR and Return Loss	■	■	■	■
1-Port Cable Loss	■	■	■	■
1-Port Phase	■	■	■	■
Smith Chart	■	■	■	■
2-Port Transmission			■	Option 002
2-Port Phase			■	
Bias Tee			Option 001	
High-Power CW Signal Generator (RF Source)			Option 005	
RF Power	■	■	■	■
Optical Power	■	■	■	■
Fiber inspection	■	■	■	■
Bluetooth connectivity		Option 003		
USB GPS connectivity		Option 004		
WiFi connectivity		Option 006		
TestWizard		Option 007		

Specifications¹

	JD723C	JD724C	JD725C	JD726C
Frequency				
Range	100 MHz – 2.7 GHz	5 MHz – 4 GHz	5 MHz – 4 GHz	5 MHz – 6 GHz
Resolution	10 kHz			
Accuracy	±25 ppm at 25°C			
Aging	± 5 ppm			
Data Points				
	126, 251, 501, 1001, 2001			
Measurement Speed				
Reflection	< 0.7 ms/point			
DTF	< 0.8 ms/point			
Measurement Accuracy				
Corrected directivity	>42 dB (typical) ² after OSL calibration			
Reflection uncertainty	±(0.3 + 20log(1 + 10-EP/20)) (typical) EP = directivity – measured return loss			
Corrected directivity	After EZ-Cal calibration: ≤ 4 GHz: >38 dB (typical) > 4 GHz: >33 dB (typical)			
Reflection uncertainty	±(0.3 + 20log(1 + 10-EP/20)) (typical) EP = directivity – measured return loss			
Output Power				
High	0 dBm (nominal)		0 dBm (nominal)	
Low			-30 dBm (nominal)	
Maximum Input Level				
Average continuous power	+25 dBm (nominal)			
DC voltage	±50 V DC			
Interference Immunity				
On channel	+15 dBm (nominal)		+17 dBm (nominal)	
On frequency	+5 dBm (nominal)		+10 dBm (nominal)	

	JD723C	JD724C	JD725C	JD726C
Measurements				
Reflection				
VSWR range	1 to 65			
Resolution	0.01			
Return loss range	0 to 60 dB			
Resolution	0.01 dB			
Distance to Fault (DTF)				
Vertical VSWR range	1 to 65			
Resolution	0.01			
Vertical return loss range	0 to 60 dB			
Vertical resolution	0.01 dB			
Horizontal range	0 to (# of data points – 1) x horizontal resolution Maximum = 1500 m (4921 ft)			
Horizontal resolution	(1.5 x 10 ⁸) x (VP)/delta VP = propagation velocity delta = stop frequency – start frequency (Hz)			
1-Port Cable Loss				
Range	0 to -30 dB			
Resolution	0.01 dB			
1-Port Phase				
Resolution	-180 to +180°			
Smith Chart				
Resolution	0.01°			
	JD725C		JD726C	
2-Port Transmission				
Output Power				
High	0 dBm (typical)			
Low	-30 dBm (typical)			
Measurement Speed				
Vector	< 1.3 ms/point			
Dynamic Range				
Vector	5 MHz to 3 GHz: 80 dB at average 5 3 GHz to 6 GHz: 75 dB at average 5			
Measurements				
<i>Insertion Loss/Gain</i>				
Range	-120 to +100 dB			
Resolution	0.01 dB			
<i>2-Port Phase</i>				
Range	-180° to +180°			
Resolution	0.01°			
Bias Tee				
Voltage				
Voltage range	+12 to +32 V			
Voltage resolution	1 V			
Current	250 mA at +32 V, 500 mA at +12 V			
High-Power CW Signal Generator				
Output Power				
Range	5 MHz to 4 GHz, -30 to +10 dBm		5 MHz to 4 GHz, -30 to +10 dBm 4 GHz to 6 GHz, -30 to +5 dBm	
Step	1 dB			
Accuracy	±1.5 dB (20 to 30°C)			

Specifications

	JD723C	JD724C	JD725C	JD726C
Bluetooth® Connectivity				
	Personal area network (PAN)			
	File transfer profile (FTP) interface			
Web-based remote control	Internet Explorer, Chrome, Safari			
WiFi Connectivity				
Interface type	USB LAN Card			
Interface standard	IEEE 802.11 b/g/n			
Web-based remote control	Internet Explorer, Chrome, Safari			
USB GPS Connectivity				
GPS location	Latitude and longitude on display			
Indicator	Latitude and longitude with trace storage			
Interface	USB 2.0			
RF Power Meter (Standard)				
Display range	-80 to +120 dBm			
Offset range	0 to 60 dB			
Resolution	0.01 dB or 0.1 x W (x = m, u, p)			
External RF Power Sensors				
Directional Power Sensor	JD731B	JD733A		
Frequency range	300 MHz – 3.8 GHz	150 MHz – 3.5 GHz		
Dynamic range	0.15 to 150 W (average) 0.1 to 50 W (average)	4 to 400 W (peak) 0.1 to 50 W (peak)		
Connector type	Type-N female on both ends			
Measurement type	Forward/reverse average power, forward peak power, VSWR			
Accuracy	±(4% of reading + 0.05 W) ^{3,4}			
Terminating Power Sensor	JD732B	JD734B	JD736B	
Frequency range	20 MHz – 3.8 GHz			
Dynamic range	-30 to +20 dBm			
Connector type	Type-N male			
Measurement type	Average	Peak	Average & Peak	
Accuracy	±7% ³			
Optical Power Meter (standard)				
Display range	-100 to +100 dBm			
Offset range	0 to 60 dB			
Resolution	0.01 dB or 0.1 mW			
External Optical Power Meters				
	MP-60	MP-80		
Wavelength range	780 to 1650 nm			
Max. permitted input level	+10 dBm	+23 dBm		
Connector input	Universal 2.5 and 1.25 mm			
Accuracy	±5%			

- Specifications for JD720C series analyzers apply under these conditions:
 - Cable and antenna measurement applies after calibrating to the OSL standard
 - The instrument is operating within a valid calibration period
 - Data with no tolerance are considered typical values
 Typical value: Expected instrument performance operating under 20 to 30°C at 15 minutes sustained. Nominal value: A general, descriptive term or parameters.
- Using recommended calibration kits. Available only for serial number KR31659001 and later.
- CW condition at 25°C ±10°C.
- Forward power.

General Information

	JD723C	JD724C	JD725C	JD726C
RF In				
Connector	N/A		Type-N, female	
Impedance	N/A		50 Ω (nominal)	
Damage level	N/A		> +25 dBm, > ±50 V DC	
Reflection/RF Out				
Connector	Type-N, female			
Impedance	50 Ω (nominal)			
Damage level	> +40 dBm, > ±50 V DC (nominal)			
Connectivity				
USB host ¹	Type A, 2 ports			
USB client ²	Mini B, 1 port			
LAN	RJ45, 10/100Base-T			
Serial	9-pin D-SUB male ³			
Display				
Type	Resistive touch screen			
Size	7-inch, LED backlight, transfective LCD			
Resolution	800 x 480			
Speaker				
	Built-in speaker			
Power				
External DC input	12 to 15 VDC			
Power consumption	12 W 34.5 W maximum (when charging battery)	15 W 37.5 W maximum (when charging battery)		
External AC Power Adapter				
Input	100 to 250 V (50 to 60 Hz, 1.2 A)			
Output	15 V DC, 4 A			
Battery				
Type	10.8 V, 7800 mA/hr (LiION)			
Operation time	>7.5 hr (typical)	>5.5 hr (typical) Bias-T off, > 3 hr Bias-T on (Max)		
Charge time	3 hr (80%), 5 hr (100%)			
Charging temperature	0 to 45°C (32 to 104°F) ≤85% RH			
Discharging temperature	-20 to 55°C (4 to 131°F) ≤85% RH			
Storage temperature ⁴	0 to 25°C (32 to 77°F) ≤95% RH (noncondensing)			
Data Storage				
Internal ⁵	Minimum 130 MB	Minimum 500 MB		
External ⁶	Limited by size of USB flash drive			
Environmental				
Operating temperature				
AC power	0 to 40°C (32 to 104°F) with no derating			
Battery	0 to 40°C (32 to 104°F) at charging -10 to 55°C (14 to 131°F) at discharging			
Maximum humidity	95% RH (noncondensing)			
Storage temperature ⁷	-40 to 70°C (-40 to +158°F)			
Shock and vibration	MIL-PRF-28800F Class 2			

- Connects flash drive, power sensor, P5000i, Bluetooth adapter, WiFi LAN card, or GPS receiver.
- Connects to PC/laptop for data transfer.
- For JD72450551/JD72450552.
- 20 to 85% RH, store battery pack in low-humidity environment; extended exposure to temperatures above 45°C could significantly degrade battery performance and life.
- UP to 3,800 traces (JD723C/JD724C) and 21,000 traces (JD725C/JD726C).
- Supports USB 2.0-compatible memory devices.
- With the battery pack removed.

General Information

	JD723C	JD724C	JD725C	JD726C
EMC (complies with European EMC)				
	EN 61326-1:2013 EN 61326-2-1:2013		EN 61326-1:2013 EN 61326-2-3:2013	
ESD				
	IEC/EN 61000-4-2			
Safety (complies with European LVD TUV NRTL)				
	EN 61010-1:2010 UL 61010-1:2012 CAN/CSA C22.2 No. 61010-1:2012		EN 61010-1:2010 UL 61010-1:2012	
RoHS				
	EN 50581:2012			
Size and Weight (with battery)				
Size (W x H x D)	260 x 190 x 60 mm (10.2 x 7.5 x 2.4 in)			
Weight	2.35 kg (5.18 lb)		2.50 kg (5.51 lb)	
Warranty				
Mainframe	3 years			
Battery and accessories	1 year			
Calibration Cycle				
	2 years			

Ordering Information

JD720C Series

Basic Model ¹	Part Number
100 MHz to 2.7 GHz	JD723C
5 MHz to 4 GHz	JD724C
5 MHz to 4 GHz 2-port (standard) ²	JD725C
5 MHz to 6 GHz 2-port (optional)	JD726C
Included Accessories	
AC/DC power adapter	
Cross LAN cable	
USB A to Mini B cable	
USB memory	
Automotive cigarette lighter/12 V DC adapter	
Rechargeable LiON battery	
Stylus pen	
Soft carrying case	
JD720C series user's manual and application software	
Options	
Bias tee ²	JD720C001
2-port transmission ³	JD720C002
Bluetooth connectivity ⁴	JD720C003
USB GPS connectivity ⁵	JD720C004
High-power CW signal generator	JD720C005

WiFi connectivity ⁶	JD720C006
TestWizard	JD720C007

NOTE: Upgrade options for the JD720C use the designation JD720CU before the respective last three-digit option number.

Optional Accessories

Calibration Kits	Part Number
Y-calibration kit Type-N(m), DC to 6 GHz, 50 Ω	JD78050509
Y-calibration kit DIN(m), DC to 6 GHz, 50 Ω	JD78050510
50 Ω load, DC to 4 GHz, 0.5 W	GC72550511 ⁷
Dual-port Type-N(m) 6 GHz calibration kit ⁸	JD78050507
Dual-port DIN(m) 6 GHz calibration kit ⁹	JD78050508
Electronic calibration kit (EZ-Cal)	JD70050509

RF Cables	Part Number
RF cable DC to 8 GHz Type-N(m) to Type-N(m), 1.0 m	G700050530
RF cable DC to 8 GHz Type-N(m) to Type-N(f), 1.5 m	G700050531
RF cable DC to 8 GHz Type-N(m) to Type-N(f), 3.0 m	G700050532
RF cable DC to 6 GHz Type-N(m) to DIN(f), 1.5 m	G710050536
Phase-stable RF cable with grip DC to 6 GHz Type-N(m) to Type-N(f), 1.5 m	G700050540
Phase-stable RF cable with grip DC to 6 GHz Type-N(m) to DIN(f), 1.5 m	G700050541

RF Power Sensors	Part Number
Directional power sensor (peak and average), 300 MHz to 3.8 GHz, average 0.15 to 150 W, peak 4 to 400 W	JD731B
Directional power sensor (peak and average), 150 MHz to 3.5 GHz, average/peak 0.1 to 50 W	JD733A
Terminating power sensor (average), 20 MHz to 3.8 GHz, -30 to +20 dBm	JD732B
Terminating power sensor (peak), 20 MHz to 3.8 GHz, -30 to +20 dBm	JD734B
Terminating power sensor (peak and average), 20 MHz to 3.8 GHz, -30 to +20 dBm	JD736B

Optional RF Adapters	Part Number
Adapter Type-N(m) to DIN(f), DC to 7.5 GHz, 50 Ω	G700050571
Adapter DIN(m) to DIN(m), DC to 7.5 GHz, 50 Ω	G700050572
Adapter Type-N(m) to SMA(f) DC to 18 GHz, 50 Ω	G700050573
Adapter Type-N(m) to BNC(f), DC to 4 GHz, 50 Ω	G700050574
Adapter Type-N(f) to Type-N(f), DC to 18 GHz 50 Ω	G700050575
Adapter Type-N(m) to DIN(m), DC to 7.5 GHz, 50 Ω	G700050576
Adapter Type-N(f) to DIN(f), DC to 7.5 GHz, 50 Ω	G700050577
Adapter Type-N(f) to DIN(m), DC to 7.5 GHz, 50 Ω	G700050578
Adapter DIN(f) to DIN(f), DC to 7.5 GHz, 50 Ω	G700050579
Adapter Type-N(m) to Type-N(m), DC to 11 GHz, 50 Ω	G700050580
Adapter N(m) to QMA(f), DC to 6 GHz, 50 Ω	G700050581
Adapter N(m) to QMA(m), DC to 6 GHz, 50 Ω	G700050582
Adapter N(m) to 41/9.5 MINI DIN (f), DC to 6 GHz, 50 Ω	G700050583
Adapter N(m) to 41/9.5 MINI DIN (m), DC to 6 GHz, 50 Ω	G700050584
Adapter N(m) to 4.3-10 (f), DC to 6.0 GHz, 50 Ω	G700050585
Adapter N(m) to 4.3-10 (m), DC to 6.0 GHz, 50 Ω	G700050586

Optional Accessories

Optical Power Meters and Fiber Microscope Kits	Part Number	Warranty and Calibration	
USB optical power meter with software, 2.5 and 1.25 mm interfaces, 30-inch USB extender, and carrying pouch	MP-60A	JD723C/724C 1-year warranty extension for Asia and North America	JD720C200
USB optical power meter — high power, with software, 2.5 and 1.25 mm interfaces, 30-inch USB extender, and carrying pouch	MP-80A	JD723C/724C 1-year warranty extension for Latin America and EMEA	JD720C201
KIT: FBP-P5000i digital probe, FiberChekPRO software, case, and four tips	FBP-SD101	Certified Calibration for JD723/724	JD723/4-CAL
KIT: FBP-P5000i digital probe, FiberChekPRO software, case, and seven tips	FBP-MTS-101	JD725C/726C 1-year warranty extension for Asia and North America	JD725C200
KIT: FBP-P5000i digital probe, MP-60A USB power meter, FiberChekPRO software, case, tips, and adapters	FIT-SD103	JD725C/726C 1-year warranty extension for Latin America and EMEA	JD725C201
KIT: FBP-P5000i digital probe, MP-60A USB power meter, FiberChekPRO software, case, tips, adapters, and cleaning materials	FIT-SD103-C	Certified calibration for JD725/726	JD725/726-CAL
KIT: FBP-P5000i digital probe, MP-80A USB power meter, FiberChekPRO software, case, tips, and adapters	FIT-SD113		
Others		<ol style="list-style-type: none"> Requires a calibration kit. For only JD725C/JD726C. Requires 2-port transmission (option 002) for JD726C. Requires 2-port calibration kit. This option 002 is standard for JD725C. Includes a USB Bluetooth dongle and dipole antenna (JD70050006). Includes a USB GPS receiver (JD70050005). Includes a WiFi dongle (JD70050008). Not available in the EU market effective July 1, 2017 Includes 1x JD78050509 Y- calibration kit, 2x G700050530 RF Cable, and 2x G700050575 RF Adapter Type-N(f) to Type-N(f) Includes 1x JD78050510 DIN Y- calibration kit, 2x G710050536 RF Cable, and 2x G700050572 RF Adapter DIN(m) to DIN(m) 	
Attenuator 40 dB, 100 W, DC to 4 GHz (unidirectional)	G710050581		
AC/DC power adapter for JD723C and JD724C only	GC72450522		
JD720C AC/DC adapter for JD725C and JD726C	JD72050522		
Cross LAN cable (1.83 m [6Ft])	G700550335		
USB A to Mini B cable (1.0 m)	JD70050536		
>1 GB USB memory	GC72450518		
Automotive cigarette lighter/12 V DC adapter	GC72450523		
Rechargeable LiON battery	G710550325		
Stylus pen	G710550316		
JD720C soft carrying case	JD72050541		
JD720 hard carrying case with wheels	JD70050542		
CellAdvisor backpack carrying case	JD70050343		
External battery charger	G710550324		
USB Bluetooth dongle and dipole antenna 5 dBi	JD70050006		
USB WiFi dongle	JD70050008		
USB GPS receiver	JD72050005		
JD720C series user's manual, printed version	JD720C362		



Contact Us **+1 844 GO VIAVI**
(+1 844 468 4284)

To reach the VIAVI office nearest you,
visit viavisolutions.com/contacts.

© 2017 VIAVI Solutions Inc.
Product specifications and descriptions in this document are subject to change without notice.
jd720c-ds-cpo-tm-ae
30173185 909 0917